

Apeos C7070 / Apeos C6570
 Apeos C5570 / Apeos C4570
 Apeos C3570 / Apeos C3070
 Apeos C2570

Reference Guides are available on the official website.
 Please go to the official website, then select your country and/or region to proceed.
 Search the model name of your machine using the search bar.



<https://fujifilm.com/fbglobal/eng/support>

User's Manual

Before using the machine, please read this manual thoroughly. Be sure to keep this manual for future reference.

- This manual may not be edited, modified or copied in whole or part without the written consent of the publisher.
- Some parts of this manual are subject to change without prior notice.
- The screen shots and the illustrations in this manual are used as examples. They may differ from yours depending on the model, the software, or the OS.

March 2024 GM1521E2-3 Edition 1

Safety Notes

Before using this product, read "Safety Notes" carefully for safety use.

This product and recommended supplies have been tested and found to comply with strict safety requirements including safety agency approvals and compliance with environmental standards. Follow the following instructions for safety use.

WARNING

Any unauthorized alteration including an addition of new functions or connection to external devices may not be covered by the product warranty. Contact your local representative for more information.

Follow all warning instructions marked on this product. The warning marks stand for the followings:

DANGER	Used for item that if not followed strictly, can lead death or severe or fatal injuries and the possibility to do it is comparatively high.
WARNING	Used for items that if not followed strictly, can lead to severe or fatal injuries.
CAUTION	Used for items that if not followed strictly, can cause injuries to user or damages to machine.

: A symbol for items to pay attention to when handling machine. Follow instructions carefully to use machine safely.

Caution	Caution for electrostatic breakage	Flammable	Explosive	Electric shock	Heated surface
Moving object	Pinched fingers	Rotating Parts Hazard			
		Sharp Edge Hazard			

: A symbol for prohibited items. Follow instructions carefully to avoid any dangerous acts.

Prohibited	No fire	Do not touch	Do not use in bathroom
Do not tear down	Keep away from wet	Never touch with wet hand	

: A symbol for items that must be performed. Follow instructions carefully to carry out these essential tasks.

Instructions	Unplug	Ground/Earth

■ Electrical Safety

⚠ WARNING

This product shall be operated by the power source as indicated on the product's data plate. Consult your local power company to check if your power source meets the requirements.

WARNING: Connect this product to a protective earth circuit.

This product is supplied with a plug that has a protective earth pin. The plug fits only into an earthed electrical outlet. This is a safety feature. If the plug doesn't fit to the outlet, contact an electrician to replace the outlet to avoid risk of electric shock. Never use an earthed adapter plug to connect the product to the electrical outlet that has no earth connection terminal. Improper connection of a grounding conductor may cause electric shock.

Plug the power cord directly into a grounded electrical outlet. To prevent overheat and a fire accident, do not use an extension cord, a multi-plug adaptor or a multiple connector. Consult your local representative to check if an outlet is grounded.

Connect this product to a branch circuit or an outlet that has larger capacity than the rated ampere and voltage of this product. See the data plate on the rear panel of this product for its rated ampere and voltage.

Never touch the power cord with wet hands. It may cause electric shock.

Do not put an object on the power cord.

Always keep the plug connection free of dust. The dusty and damp environment may bring about minute electric current in a connector. It may generate heat and eventually cause a fire accident.

To avoid the risk of electric shock and a fire accident, only use the power cord supplied with this product or the ones designated by our company. The power cord is exclusive use for this product. Do not use it for any other product. Do not damage or alter the power cord. Damage and alteration may generate heat and eventually cause electric shock or a fire accident. If the power cord is damaged or insulated wires are exposed, contact your local representative for its replacement. Do not use a damaged or uninsulated cord to avoid the risk of electric shock and a fire accident.

⚠ CAUTION

Unplug this product to turn off power completely. Install this product near an outlet to easily unplug it in case of emergency.

When cleaning this product, always switch off and unplug it. Access to a live product interior may cause electric shock.

Do not unplug or re-plug this product with the switch on. Plugging and unplugging a live connector may deform the plug and generate heat, and eventually cause a fire accident.

Hold the plug not the cord when unplugging this product, or it may damage the cord and cause electric shock or a fire accident.

Switch off and unplug the product when it (i.e., fax function) is not used over weekends or long holidays. Please note that it cannot receive fax message during switch-off.

Once a month, switch off this product and check if

- the power cord is plugged firmly into an electrical outlet;

- the plug is not excessively heated, rusted or bent;
- the plug and electrical outlet are free of dust; and
- the power cord is not cracked or worn down.

Once you notice any unusual condition, switch off and unplug this product first and contact your local representative.

■ Product Installation

⚠ WARNING

Do not locate this product where people might step on or trip over the power cord. Friction or excessive pressure may generate heat and eventually cause electric shock or a fire accident.

⚠ CAUTION

Never locate this product in the following places:

- Near radiators or any other heat sources
- Near volatile flammable materials such as curtains
- In the hot, humid, dusty or poorly ventilated environment
- In the place receiving direct sunlight
- Near cookers or humidifiers

Keep away the packing materials of product from small children. The thin film may cling to nose and mouth and prevent breathing.

Locate this product on a level and sturdy surface that can withstand a weight of 120 Kg (minimum configuration). Otherwise, if tilted, the product may fall over and cause injuries.

Locate this product in a well-ventilated area. Do not obstruct ventilation openings of the product. Keep the minimum clearance as shown in the next figure for ventilation and an access to the power plug. Unplug the product if an abnormal condition is noted.

Minimum configuration

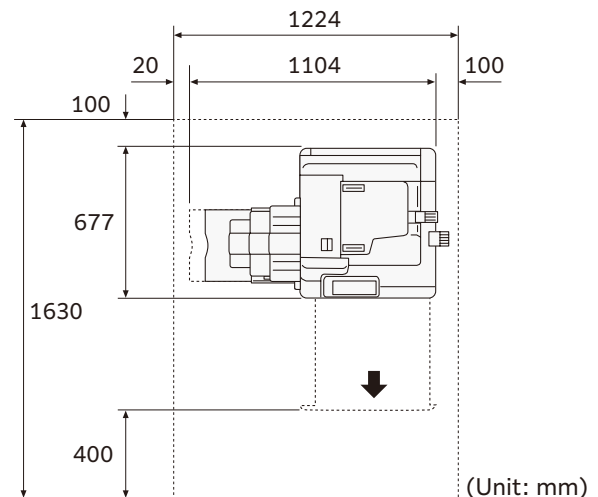

Do not incline the product at more than 10° angle. Otherwise, it may fall over and cause injuries.

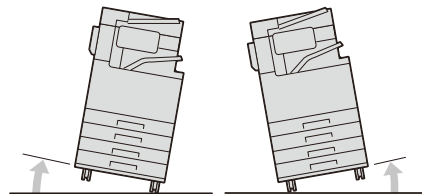



Always lock the wheels of this product after installation. Otherwise, it may fall over or slide and cause injuries.

To bundle wires and cables, always use the cable ties and spiral tubes that our company supplies. Otherwise, it may cause some defects.

Operational Safety

WARNING

 The operator's product maintenance procedures are described in the manuals supplied with this product. Do not carry out any other maintenance procedures not described in the manuals.

 This product features safety design not to allow operators access to hazard areas. The hazard areas are isolated from operators by covers or protectors which require a tool to remove. To prevent electric shock and injuries, never remove those covers and protectors.

 To avoid the risk of electric shock and a fire accident, switch off and unplug the product promptly in the following conditions, then contact your local representative.

- The product emits smoke or its surface is unusually hot.
- The product emits unusual noise or odour.
- The power cord is cracked or worn down.
- A circuit breaker, fuse or any other safety device becomes activated.
- Any liquid is spilled into the product.
- The product is soaked in water.
- Any part of the product is damaged.

 Do not insert any object into slots or openings of this product. Do not put any of the followings on the product:

- Liquid container such as flower vases or coffee cups
- Metal parts such as staples or clips
- Heavy objects

If liquid is spilled over or metal parts are slipped into the product, it may cause electric shock or a fire accident.

 Do not use conductive paper such as origami paper, carbonic paper, conductively-coated paper or conductive ink preprinted paper. When paper jam occurs, it may cause short-circuit and eventually a fire accident.

 When cleaning this product, use the designated cleaning materials exclusive to it. Other cleaning materials may result in poor performance of the product. Never use aerosol cleaners to avoid catching fire and explosion.

 Do not pull out two or more paper trays at a time. If somebody accidentally pushes the product with multiple trays open, it may incline and fall over. This may cause injuries. When you need to open paper trays, do it one after the other.

 If you need to pull out a tray to remove paper jam, contact your local representative. Do not pull out a tray, otherwise it may cause injuries.

 When you play the media (e.g., CD-ROM, DVD) supplied with the product, always use said media-enabled device. Otherwise, large sound may damage its speakers or your ears.

CAUTION

 Always follow all warning instructions marked on or supplied with this product. To avoid the risk of burn injuries and electric shock, never touch the area with the "High Temperature" or "High Voltage" marks on.

 Keep electrical and mechanical safety interlocks active. Keep the safety interlocks away from magnetic materials. Magnetic materials may accidentally activate the product and cause injuries or electric shock.

 A ground fault interrupter is embedded in this product. If current leakage occurs, the ground fault interrupter automatically cuts off power circuit to prevent electric shock and a fire accident. The ground fault interrupter is normally ON. Check once a month if the ground fault interrupter works properly in accordance with the following procedures:

1. Switch off the product.

2. Press the RESET button to the reset position. The button will be depressed even after the pushing force is released.

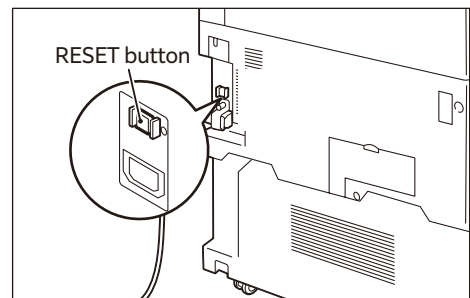

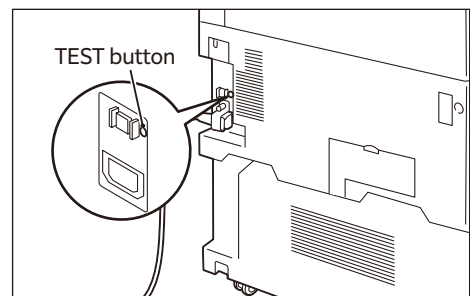

3. Press the TEST button lightly with a sharp edge such as a pen tip. The depressed RESET button will stick out again. This is the end of the check procedure.





4. Press the RESET button back to the depressed position.

If the circuit does not work properly, contact your local representative.

 Do not attempt to remove a paper deeply jammed inside the product, particularly a paper wrapped around the fusing unit or the heat roller. Otherwise, it may cause injuries or burns. Switch off the product immediately and contact your local representative.

  Never touch the paper output area of the finisher during operation. It may cause injuries.

  Be careful in removing jammed staples.

 Waste staples may come out with output paper. Be careful not to get injured by the staples.

 Never touch safety interlocks. When a front cover is open, safety interlocks become activated to stop the machinery. Do not apply pressure on safety interlocks with a coin or screwdriver. Otherwise, the machinery may become activated and cause injuries.

 Do not staple punched holes of paper. Sharp points of a staple may cause injuries.

 Do not apply excessive force to hold thick document on the document glass. It may break the glass and cause injuries.

 For continuous operation more than 1 hour, take a 10 - 15 minute break every hour to rest your eyes.

 To move this product to another location, contact your local representative.

 Ventilate well during extended operation or mass copying or printing. It may affect the office air environment due to odor such as ozone in a poorly ventilated room.

Provide proper ventilation to ensure the comfortable and safe environment.

■ Consumable

WARNING

 Store all consumables in accordance with the instructions given on its package or container.

 Never use a vacuum cleaner for spilled toner and residual toner in this product, toner cartridge or waste toner container. It may catch fire by electric sparks inside a vacuum cleaner and cause explosion. Use a broom or a wet cloth to wipe off the spills. If you spill a large volume of toner, contact your local representative.

 Never throw a toner cartridge into an open flame. Remaining toner in the cartridge may catch fire and cause burn injuries or explosion. If you have a used toner cartridge no longer needed, contact your local representative for its disposal.

 Never throw a waste toner container into an open flame. Toner may catch fire and cause burn injuries or explosion. If you have a used waste toner container no longer needed, contact your local representative for its disposal.

CAUTION

 Keep drum cartridges and toner cartridges out of the reach of children. If a child accidentally swallows toner, spit it out, rinse mouth with water, drink water and consult a physician immediately.

 When replacing drum cartridges and toner cartridges, be careful not to spill the toner. In case of any toner spills, avoid contact with clothes, skin, eyes and mouth as well as inhalation.

 ■ If toner spills onto your skin or clothing, wash it off with soap and water.

 ■ If you get toner particles in the eyes, wash it out with plenty of water for at least 15 minutes until irritation is gone. Consult a physician if necessary.

■ If you inhale toner particles, move to a fresh air location and rinse your mouth with water.

■ If you swallow toner, spit it out, rinse your mouth with water, drink plenty of water and consult a physician immediately.

■ Other

This product emits weak electromagnetic waves. If you have a medical device implanted (e.g., a cardiac pacemaker) and get out of shape, keep away from this product immediately and consult a physician.

■ Regulation

 Shielded interface cables must be used with this product to maintain compliance with EMI standard.

More online support options.....

TO ACCESS MORE ONLINE SUPPORT OPTIONS

Please go to our website, <https://fujifilm.com/fbglobal/eng/support> and then select your country to proceed.

■ Drivers & Utilities

ACCESS THE LATEST PRODUCT SUPPORT TOOLS ONLINE

Fully tested printer drivers, utilities and software patches are available for our products.

■ Self Help

SELF DIRECTED SUPPORT READY WHEN YOU NEED IT

Solutions are provided in multiple languages. Download useful posters, "How-to" guides, video tutorials and more. Designed for desktop and mobile viewing, our site provides fast and self-directed support in seconds and minutes.

Need more support?

■ eLogging

TECHNICAL SUPPORT CENTRE

Log hardware or software support requests online via your local support website.

Our people are highly skilled, industry certified professionals. Accessing state of the art laboratories and remote diagnostic tools to replicate problems and provide timely solutions.

With direct access to product development and engineering, this focused team assists in the resolution of complex technical issues.

■ Contact us

Localized Technical Support Centre phone details can be accessed via the "Contact" link for your country.

Go to, <https://fujifilm.com/fbglobal/eng/support> and then select your country to proceed.

Software License Agreement

You must read and agree with the following terms and conditions before you open the package and use the media accompanying the device. By opening the package, you agree to be bound by the terms and conditions.

Term and conditions

- Our company does not provide any implicit or explicit guarantee on the contents, accuracy and safety of the media.
- The copyrights of the information provided in this media belongs to our company
- The contents of this media shall not be duplicated, modified, sold, published, read or disclosed to a third party for any amount of money whatsoever.

Disclaimer

Our company is not liable for any direct, indirect or spillover damages; loss of data, program or intangible properties; and lost profits arising out of the use of this software.

Read Before Using

Before using the machine, please read "License Agreement" (terms for using the Adobe Inc. software) stored on the "Software/Product Manual" disc.

"License Agreement" is stored in the "License" folder contained on the disc.

Use the software only after you agree with all applicable terms and conditions. By using the software, you are agreeing to be bound by the terms and conditions. If you do not agree to "License Agreement", please contact the dealer you purchased the product.

Please refer to the official website for the status of security certification.

If you use the product as an ISO/IEC 15408 certified product, please refer to the "Security Function Supplementary Guide" of this model from the official website and make sure to configure the settings appropriately.